

# Positive displacement meters series **LBM 1000 - LBM 3000**



LBM 3000 with mechanical counter



LBM 3000 with VEGA II

[www.isoilmeter.com](http://www.isoilmeter.com)



## Positive displacement meters series LBM 1000 - LBM 3000

LBM 3000 with mechanical counter    LBM 3000 with EM6422 and VEGA II

ISOIL PD meter series **LBM** sizes 8" and 10" offers high accuracy over a large range of flow rate. This accuracy remains constant during long periods of use.

Visual indication of the flow rate measured can be obtained when associated with mechanical counter or electronic flow computer directly mounted on the meter or remote by means of a pulses emitter (see VEGA II or VEGA T leaflets).

### Applications

- » for barges loading
- » petroleum products transfer in refineries, loading terminals and pipelines

### Filtering and air elimination

To assure a measuring accuracy and preserve the meter from damage, the fluid under measurement must be properly filtered and air or gas must be eliminated. Isoil produces a wide range of strainers and strainer – air separators.

### Operation

While rotating, the vanes are driven by the internal surface of the single body. This means that the self – lubricating vanes are always in contact with the internal surface of measuring chamber, therefore product leakage is avoided and though high accuracy is granted.

The calibration mechanism allows micrometric adjustment. It is not necessary to change gears.

When an electronic counter is remote, the meter mounts a pulses emitter or encoder (see Encoder Isoil EM6422 data sheet).



LBM 3000 with mechanical counter

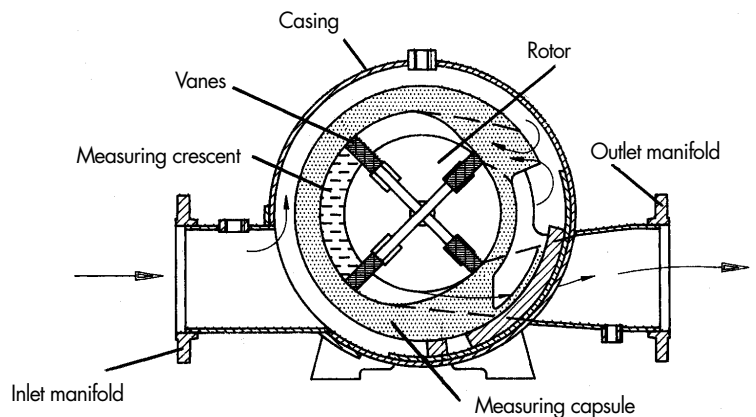

### Accuracy curves

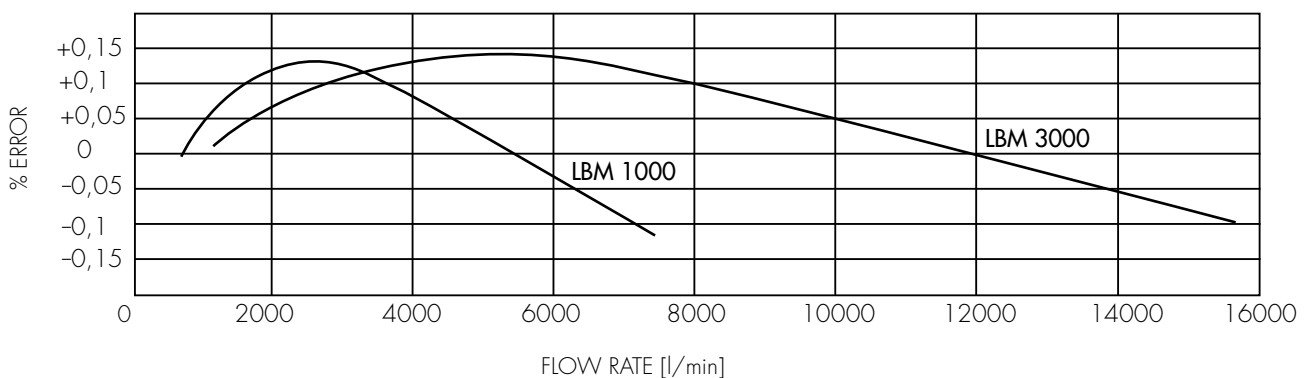

## Technical specifications

	STANDARD		UPON REQUEST
	LBM 1000	LBM 3000	
<b>EU Directives compliance</b>	ATEX and PED		
<b>Working conditions</b>			
Flow rate:	[700; 7,850] l/min @ 10 cSt	[1,500; 15,700] l/min @ 10 cSt	
Working pressure:	1,930 kPa max @ 37°C	1,930 kPa max @ 37°C	Higher values
Test pressure:	2,990 kPa	2,990 kPa	Higher values
Working temperature:	[-30; +100] °C*	[-30; +100] °C*	Higher and lower values
<b>Construction</b>			
Manifold and flanges:	Carbon Steel	Carbon Steel	Carbon Steel for low temperature
External body and covers:	Carbon Steel	Carbon Steel	Carbon Steel for low temperature
Internal body:	Cast Iron Meehanite	Cast Iron Meehanite	
Internal Covers:	Cast Iron Meehanite	Cast Iron Meehanite	
Rotor:	Cast Iron Meehanite	Cast Iron Meehanite	
Vanes:	Aluminium with rilsan tip (max 60°C)	Aluminium with rilsan tip (max 60°C)	Aluminium with PTFE tip (T>60°C)
Gaskets:	Nitrile	Nitrile	Viton
Ball Bearings:	Stainless Steel	Stainless Steel	
Seal:	Mechanical	Mechanical	Magnetic drive
Flanged:	8" ANSI 150 RF	10" ANSI 150 RF	Others upon request
Readout:	m <sup>3</sup>	m <sup>3</sup>	Others upon request
Flow direction:	Left (IN) to right (OUT)	Left (IN) to right (OUT)	Right (IN) to left (OUT)
<b>Performances</b>			
Accuracy:	± 0.15%	± 0.15%	
Repeatability:	± 0.02%	± 0.02%	
Pressure drop:	Refer to the diagram attached	Refer to the diagram attached	

\* Temperature range, printed on plate, will always span 60° C

### Pressure drop curves

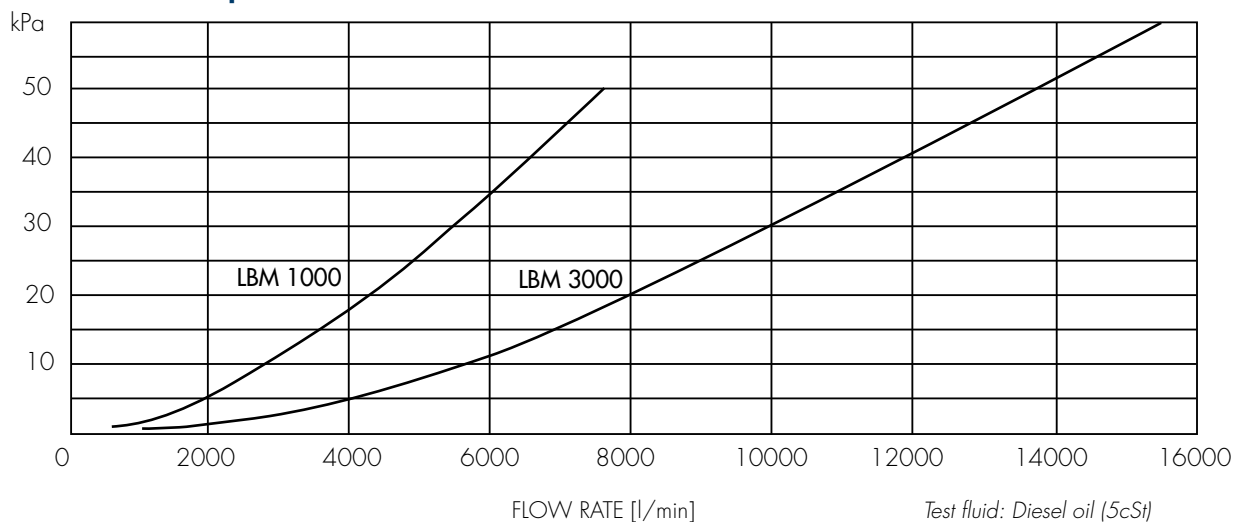

## Accessories

### Pulses emitter

Encoder EM6422 Ex-d. Pulses emitter EM 345 Eex-i or EM T2 Exd incorporated in Veeder Root 7887 register

### With VEGA II compensation

Is achieved by an algorithm based on "alfa" coefficient or density

### Extension for mechanical counter

L = 250 mm e 500 mm

### ISOVALVE automatic valve

8" , 10" Flow limiting, no return

## P.D. meter with mechanical counter

### LBM 1000 8"

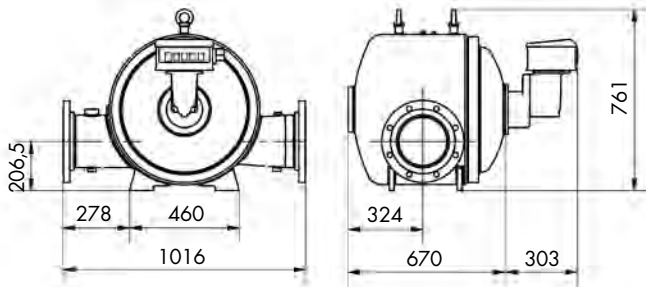

### LBM 3000 10"

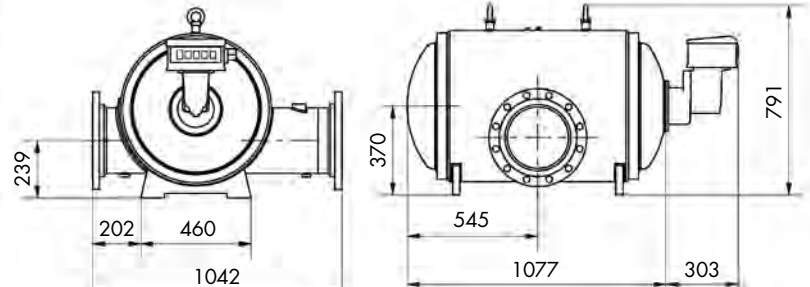

## P.D. meter with EM6422

### LBM 1000 8"

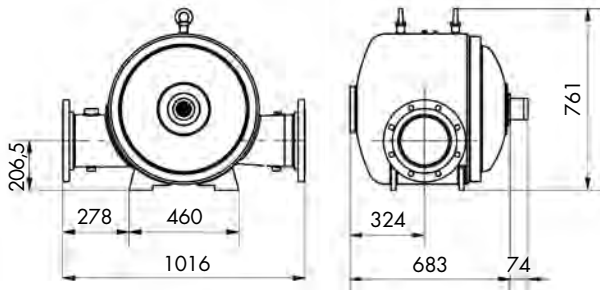

### LBM 3000 10"

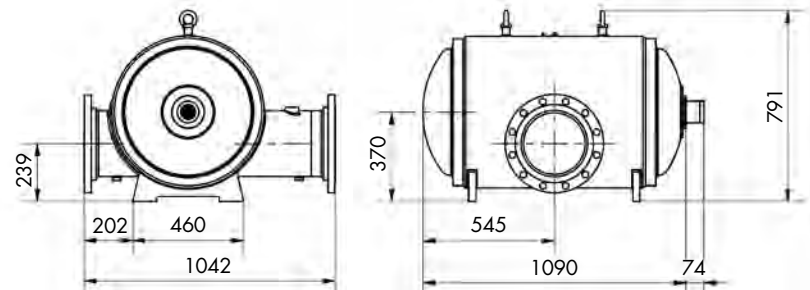

## P.D. meter with EM6422

Type	Weight
<b>LBM 1000</b>	432 Kg
<b>LBM 3000</b>	797 Kg

## P.D. meter with mechanical counter

Type	Weight
<b>LBM 1000</b>	440 Kg
<b>LBM 3000</b>	805 Kg

Accessorie	Weight
<b>Printer</b>	5 Kg